



CCD Camera BG B/W Series

BG030

BG031

BG080

BG130

BG202

Specifications

Ver4.0

TOSHIBA TELI CORPORATION

Information contained in this document is subject to change without prior notice.

Contents

1	Overview	5
2	Feature	5
3	Configuration	6
4	Optional part	6
5	Functions	7
6	Specifications	13
7	Timing chart	22
8	Warranty rules	26
9	Repair	27
10	Outline Drawing	28

RESTRICTION FOR USE

- Should the equipment be used in the following conditions or environments, give consideration to safety measures and inform us of such usage:
 1. Use of the equipment in the conditions or environment contrary to those specified, or use outdoors.
 2. Use of the equipment in applications expected to cause potential hazard to people or property, which require special safety measures to be adopted.
- This product can be used under diverse operating conditions. Determination of applicability of equipment or devices concerned shall be determined after analysis or testing as necessary by the designer of such equipment or devices, or personnel related to the specifications. Such designer or personnel shall assure the performance and safety of the equipment or devices.
- This product is not designed or manufactured to be used for control of equipment directly concerned with human life (*1) or equipment relating to maintenance of public services/functions involving factors of safety (*2). Therefore, the product shall not be used for such applications.
 - (*1): Equipment directly concerned with human life refers to.
 - Medical equipment such as life-support systems, equipment for operating theaters.
 - Exhaust control equipment for exhaust gases such as toxic fumes or smoke.
 - Equipment mandatory to be installed by various laws and regulations such as the Fire Act or Building Standard Law
 - Equipment related to the above
 - (*2): Equipment relating to maintenance of public services/functions involving factors of safety refers to.
 - Traffic control systems for air transportation, railways, roads, or marine transportation
 - Equipment for nuclear power generation
 - Equipment related to the above

CASES FOR INDEMNITY (LIMITED WARRANTY)

We disclaim any responsibility and shall be held harmless for any damages or losses incurred by the user in any of the following cases;

- Natural disasters, such as an earthquake and thunder, fire or any other act of God; acts by third parties; misuse by the user, whether intentional or accidental; use under extreme operating conditions.
- Malfunction or non-function resulting in indirect, additional or consequential damages, including but not limited to loss of expected income and suspension of business activities.
- Incorrect use not in compliance with instructions in this instruction specifications, manual and "ATTENTION FOR SAFETY".
- Damage which arose by the operation method except writing in specifications or a manual.
- Malfunctions resulting from misconnection to other equipment or combination which is not meant with software etc.
- Repairs or modifications made by the user or caused to be made by the user and carried out by an unauthorized third party.
- Notwithstanding the foregoing, Teli's liabilities shall not, in any circumstances, exceed the purchase price of the product.
- About the item which does not have a publication in the specifications and manual of this product, it considers as the outside for a guarantee.
- The attachment mistake of a cable.

USAGE PRECAUTIONS

- **Handle carefully**

Do not drop the equipment or allow it to be subject to strong impact or vibration, as such action may cause malfunctions. Further, do not damage the connection cable, since this may cause wire breakage.

- **Environmental operating conditions**

Do not use the product in locations where the ambient temperature or humidity exceeds the specifications.

Otherwise, image quality may be degraded or internal components may be adversely affected. In particular, do not use the product in areas exposed to direct sunlight. Moreover, during shooting under high temperatures, vertical stripes or white spots (noise) may be produced, depending on the subject or camera conditions (such as increased gain). However, such phenomena are not malfunctions.

- **Combination of C-mount lens**

Depending on the lens you use, the performance of the camera may not be brought out fully due to the deterioration in resolution and brightness in the peripheral area, occurrence of a ghost, aberration and others. When you check the combination between the lens and camera, be sure to use the lens you actually use.

When installing a lens in the camera, make sure carefully that it is not tilted.

In addition, use a mounting screw free from defects and dirt. Otherwise, the camera may be unable to be removed.

As for the C-mount lens used combining this product, the projection distance from bottom of the screw should use 10mm or less.

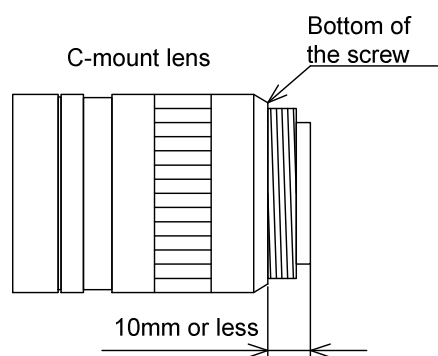

- **Do not shoot under intense light**

Avoid intense light such as spot lights on part of the screen because it may cause blooming or smears. If intense light falls on the screen, vertical stripes may appear on the screen, but this is not a malfunction.

- **Do not expose the camera's image-pickup-plane to sunlight or other intense light directly**

Its inner CCD (charge-coupled device) might be damaged.

USAGE PRECAUTIONS

- **Occurrence of moiré**

If you shoot thin stripe patterns, moiré patterns (interference fringes) may appear. This is not a malfunction.

- **Occurrence of noise on the screen**

If an intense magnetic or electromagnetic field is generated near the camera or connection cable, noise may be generated on the screen. If this occurs, move the camera or the cable.

- **Handling of the protective cap**

If the camera is not in use, attach the lens cap to the camera to protect the image pickup surface.

- **If the equipment is not to be used for a long duration**

Turn off power to the camera for safety.

- **Maintenance**

Turn off power to the equipment and wipe it with a dry cloth.

If it becomes severely contaminated, gently wipe the affected areas with a soft cloth dampened with diluted neutral detergent. Never use alcohol, benzene, thinner, or other chemicals because such chemicals may damage or discolor the paint and indications.

If the image pickup surface becomes dusty, contaminated, or scratched, consult your sales representative.

- **Disposal**

When disposing of the camera, it may be necessary to disassemble it into separate parts, in accordance with the laws and regulations of your country and/or municipality concerning environmental contamination.

This product is marked this symbol to subject to EU Waste Electrical & Electronic Equipment (WEEE) directive.

Following information is only for EU-member states:

The use of the symbol indicates that this product may not be treated as household waste. By ensuring this product is disposed of correctly, you will help prevent potential negative consequences for the environment and human health, which could otherwise be caused by inappropriate waste handling of this product. For more detailed information about the take-back and recycling of this product, please contact your supplier where you purchased the product.

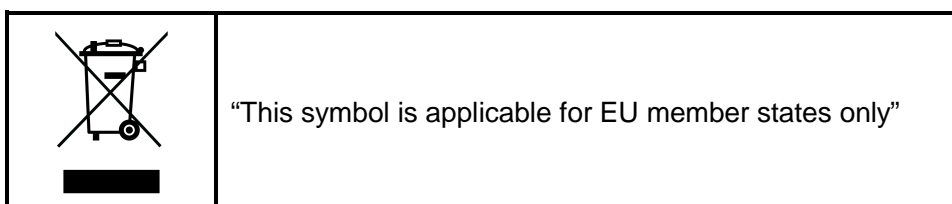

1 Overview

This BG B/W series is an integrated-(one-body)-type monochrome camera that adopts all pixel data readout inter line CCD. There are 5 models according to the sensor type. These are BG030 (VGA 1/3 type), BG031 (VGA 1/2 type), BG080 (XGA), BG130 (SXGA), BG202 (UXGA). For video output and camera control, the Gigabit Ethernet®* interface standard "IEEE802.3ab" is adopted for high transfer rate, and it is easy to integrate into industrial equipment.

* Ethernet® is a registered trademark of XEROX Corporation.

2 Feature

2.1 High frame rate and high resolution

Supported high frame rate BG030 (125fps/VGA), BG031 (125fps/VGA), BG080 (40fps/XGA), BG130 (30fps/SXGA), BG202 (20fps/UXGA).

2.2 All pixel readout

All pixel signals (in the effective area) are output in one frame processing.

2.3 Full frame shutter

Since all pixels are output even in Random Trigger Shutter operation, high resolution can be achieved, without deteriorating the vertical resolution.

2.4 Square grids

The CCD pixels arrayed in square grids facilitates computation for image processing.

2.5 Gigabit Ethernet interface (Power over Ethernet)

Video output and camera control are performed via the Gigabit Ethernet standard IEEE802.3ab interface. Data transfer is up to 1Gbps (Maximum) that enables to output uncompressed video data at high frame rate. By complying with IEEE802.3af Power over Ethernet (PoE), the power is supplied over single cable.

2.6 GigEVision Ver 1.2 conformity

This product is based on GigEVision Camera Interface Standard for Machine Vision Ver 1.2.

2.7 GenICam Ver 2.3 conformity

This product is based on GenICam Generic Interface for Cameras Ver 2.3.

2.8 Binning mode

This mode achieves high frame rate by adding two vertical lines or four vertical lines.

2.9 Random Trigger Shutter

The Random Trigger Shutter function provides images in any timing by input of an external trigger signal. Trigger control from PC is available as well.

2.10 Scalable

Selectable video output area. This mode achieves higher frame rate by reducing vertical output area. And reduces occupied data rate of Gigabit Ethernet by reducing horizontal output area.

2.11 Compact and lightweight

This camera is compact and lightweight; it is easy to integrate into industrial equipment.

2.12 EU RoHS & Chinese ROHS

3 Configuration

3.1 Camera body 1

* No application software and manuals are attached to this camera.

4 Optional part

- Camera mounting kit Model name: CPT8600
- Camera Cable CPCBG-xx

* Contact your dealer / distributor for details of option units.

5 Functions

5.1 Gain

Manual gain and automatic gain control (AGC) are available. In AGC mode, camera gain is automatically adjusted to suit subject brightness.

Notes on gain setting:

Setting the gain value too high increases noises. When you adjust the brightness of the image, I ask you to have final image quality checked with your environment.

5.2 Black Level

Black level is adjustable from -5% to +25% as white saturation level is 100%.

5.3 Gamma

Gamma correction curve is adjustable from 0.45 to 1.00.

5.4 LUT (Look Up Table)

Arbitrary curve and binarization are possible by using 10 bit input and 10 bit output LUT.

5.5 Packet Resend

GigEVision Packet Resend feature is supported.

5.6 Exposure Time

Automatic exposure time control (AE) and manual exposure time (MANUAL) are available.

5.6.1 AE

The exposure time is adjusted automatically to suit subject brightness.

This mode can also operate with AGC (Automatic Gain Control) to automatically adjust fluctuations in subject brightness across a wide range (ALC operation).

5.6.2 MANUAL

Exposure time is adjustable by micro-second unit.

5.7 Random Trigger Shutter

An image is captured at the desired timing using trigger signal input. External trigger signal from trigger input connector and software trigger from control command are available. Trigger polarity is selectable (High active / Low active).

Note that Random Trigger Shutter will cause a delay between trigger signal and start of exposure. See 7. Timing Chart for detail.

- Timed mode The exposure time is determined by Exposure Time setting.
- TriggerWidth mode The exposure time is determined by the pulse width of the trigger signal.

Notes on long exposure:

When you set the exposure time longer than approximately 1 second, white spots and the unevenness in highlight portion might occasionally be observed on screen. This phenomenon is due to the characteristics of the CCD device. It's not a malfunction of the camera itself.

Notes on Random Trigger Shutter mode:

- In the period when FRAME_TRIGGER_WAIT signal is inactive, user must not input external trigger signal to this camera.
- When the interval of the input trigger signal is extremely short, or when the trigger signal is noisy, there is a possibility of causing the malfunction. In this case, please input a proper trigger signal.

5.8 Trigger Delay

You can add the delay between trigger signal input and the start of exposure.

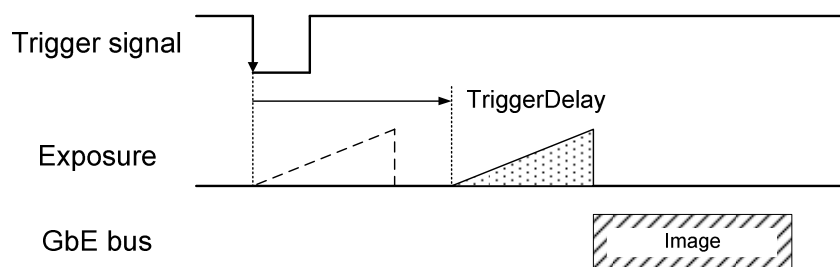

5.9 Anti-Chattering

Anti-Chattering control filters noise and unstable logic value of the trigger input signal.

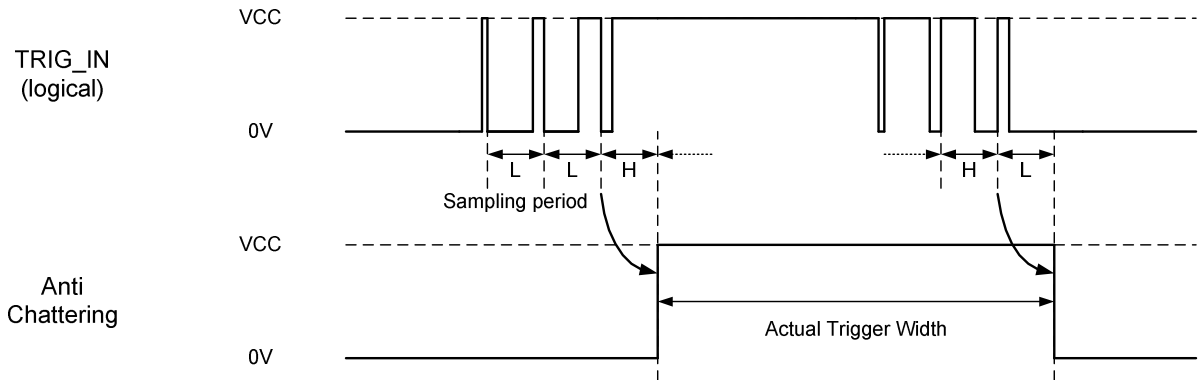

5.10 Event

Camera notifies of FrameTrigger status and ALC information by GigEVision Event Packet.

- FrameTrigger : Reception of Frame Start Trigger
- FrameTriggerError : Rejection of Frame Start Trigger
- FrameTriggerWait : Start of waiting for Frame Start Trigger
- ALCLatestInformation : ALC Information is updated
- ALCConverged : ALC is converged

FrameTrigger events timing are as following chart.

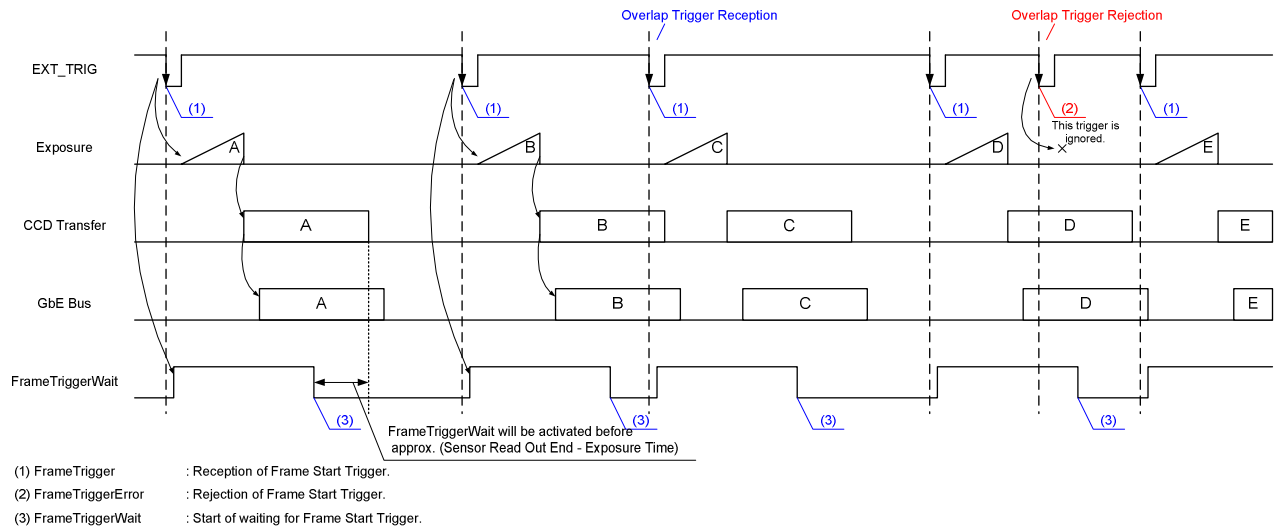

5.11 GPIO

Selected signals are output from GPIO pins of I/O connector. Following signals are selectable.

- VD : Internal VD sync signal.
- TIMER0 ACTIVE : This signal can be used as strobe control signal. The delay time and pulse width of this signal are configurable.
- EXPOSURE ACTIVE : Period from exposure start to end.
- FRAME ACTIVE : Period from exposure start to CCD transfer completion.
- FRAME TRANSFER : Period of Ethernet packet transfer.
- FRAME TRIGGER WAIT : Indicating waiting a Random Trigger Shutter. An External trigger is input during this period, exposure starts immediately.

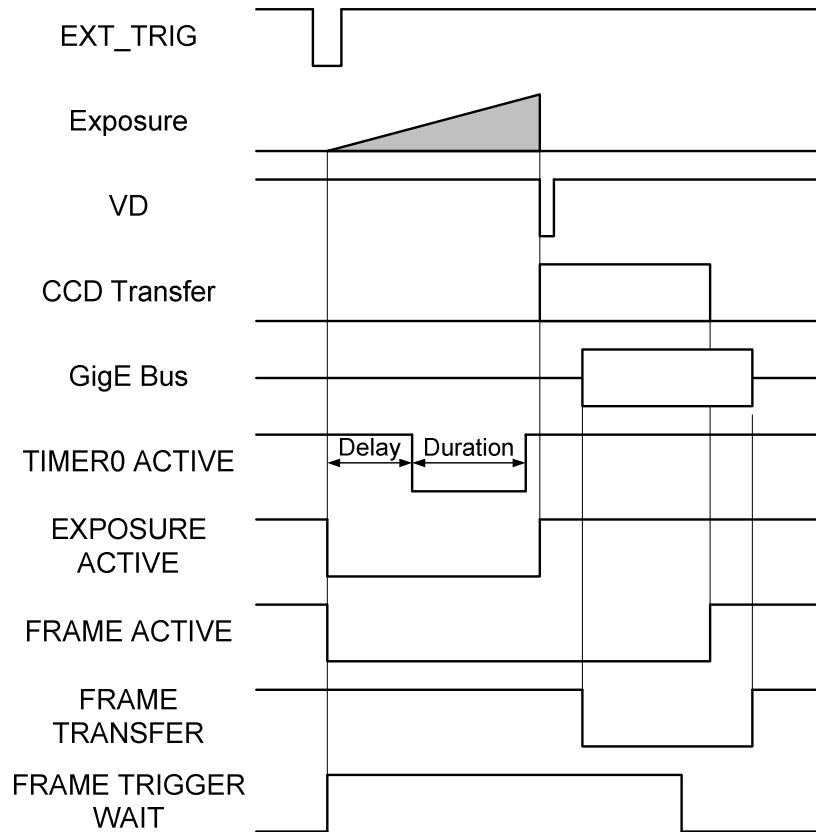

* GPIO:default=Active Low

5.12 Scalable mode

Scalable mode is to read out arbitrary area of the image. Only single rectangle is selectable. Concave or convex shape is not selectable.

- Window size: $\{A \times m \text{ (H)}\} \times \{B \times n \text{ (V)}\}$

A, B = minimum unit size

m, n = integer

The window size is equal or less than maximum image size.

- Start address: $\{32 \times i \text{ (H)}\} \times \{12 \times j \text{ (V)}\}$

i, j = integer

The window size is equal or less than maximum image size.

Model	BG030	BG031	BG080	BG130	BG202
Minimum unit size (H) x (V)	160 x 60	160 x 60	256 x 96	160 x 60	160 x 60
Maximum unit size (H) x (V)	640 x 480	640 x 480	1024 x 768	1280 x 960	1600 x 1200

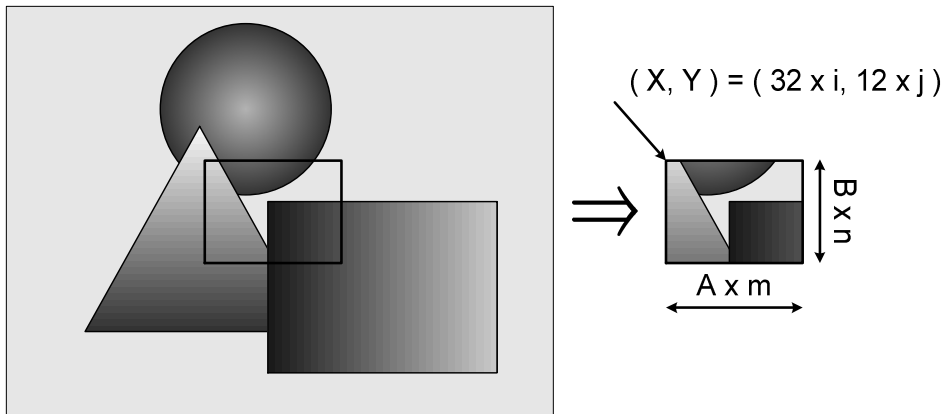

In the scalable mode, camera reads out only necessary area at the normal speed and reads out other area at high speed. The frame rate can be faster when the vertical height size is small. However, the frame rate cannot be faster only when the horizontal width size is small, due to the operation mechanism of the CCD sensor.

Notes on scalable mode:

White lines may occur in the upper portions of the screen when strong light exists in a wide area during the scalable mode. This is not a malfunction. If white lines occur, adjust the amount of incident light using the lens.

5.13 Binning Mode

In the binning mode, pixel data is combined by vertical and horizontal.

* Binning mode and Scalable mode can not operate at the same time.

Model	BG030	BG031	BG080	BG130	BG202
Binning mode (H) x (V)	2 x 2	2 x 2	2 x 2	2 x 2	2 x 2

5.14 User Free Memory

A free memory area is available to read and write arbitrary data for user. Individual numbers can be assigned when multiple BG cameras are connected.

5.15 Test Pattern

Following test patterns are available

- Black : Full screen 0 LSB (@ 8-bit)
- White : All pixels 255 LSB (@ 8-bit)
- Bright Gray : Full screen 85 LSB (01010101B) (@ 8-bit)
- Dark Gray : Full screen 170 LSB (10101010B) (@ 8-bit)
- Ramp waveform

6 Specifications

6.1 Electrical specification

Model	BG030	BG031	BG080	BG130	BG202
Imager	all-pixel-data-readout interline transfer CCD				
Number of total pixels (H) x (V)	692 x 504	692 x 504	1077 x 788	1348 x 976	1688 x 1248
Number of effective pixels (H) x (V)	659 x 494	659 x 494	1034 x 779	1296 x 966	1628 x 1236
Number of Video out pixels (H) x (V)	640 x 480	640 x 480	1024 x 768	1280 x 960	1600 x 1200
Scanning area (H) x (V) [mm]	4.88 x 3.66 (1/3 type)	6.52 x 4.89 (1/2 type)	4.81 x 3.62 (1/3 type)	4.86 x 3.62 (1/3 type)	7.16 x 5.44 (1/1.8 type)
Pixel size (H) x (V) [μm]	7.4 x 7.4	9.9 x 9.9	4.65 x 4.65	3.75 x 3.75	4.40 x 4.40
Scan method	Non-interlace				
Aspect ratio	4: 3				
Standard sensitivity	1700lx F5.6, 1/125s	1700lx F5.6, 1/125s	1700lx F5.6, 1/40s	1300lx F8, 1/30s	525lx F8,1/20s
Minimum sensitivity	F1.4, Gain +18dB, Video level 50%				
	7lx	7lx	7lx	3lx	2lx
Brightness	-5% to +25% (factory setting : 0% [0LSB@8bit])				
Gamma	$\gamma=1.00$ to 0.45 (factory setting : $\gamma=1.00$)				
LUT	Input 10 bit, Output 10 bit				
Gain	MANUAL, AGC (factory setting: MANUAL)				
Setting range	0dB to +18dB (factory setting: 0dB)				
AGC effective area	Full / Medium / Small				
Number of Memory channel	3 channels				
User Free Memory	16 Byte				
Test Pattern	Black, White, Bright Gray, Dark Gray, Ramp waveform (factory setting: OFF)				
Power supply	PoE (Power over Ethernet IEEE802.3af compliant) or DC+12V $\pm 10\%$ (ripple 100 mV(p-p) or less)				
Power consumption(*1)	PoE	3.2W Max			3.6W Max
	DC12V	2.8W Max			3.2W Max

*1 at the all pixel readout

6.2 Internal sync signal specification

Model	BG030	BG031	BG080	BG130	BG202
Fundamental clock frequency	50.000 MHz ± 100ppm	50.000 MHz ± 100ppm	45.000 MHz ± 100ppm	50.000 MHz ± 100ppm	48.000 MHz ± 100ppm

6.3 Electronic shutter specification

Exposure time	MANUAL, AE (factory setting: MANUAL)				
MANUAL	10μs to 16s	10μs to 16s	30μs to 16s	30μs to 16s	30μs to 16s
AE effective range	10μs to 16s	10μs to 16s	30μs to 16s	30μs to 16s	30μs to 16s
AE effective area	Full (Full pixel) / Medium (Central: 80% x 80%) / Small (Central: 40% x 40%)				
AE Exposure value	±2EV				

6.4 Random Trigger Shutter specification

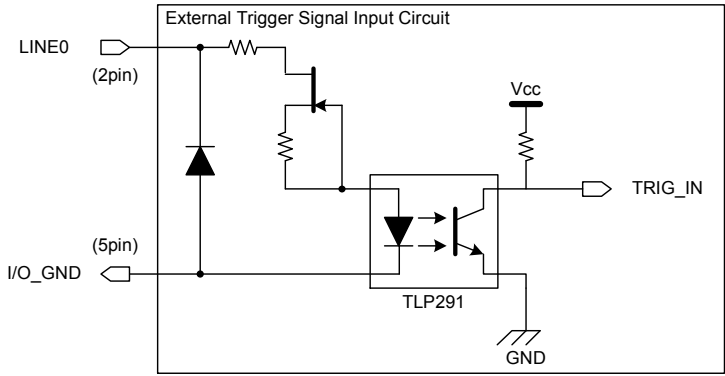
Trigger Mode	External trigger, Software trigger (factory setting: External trigger)
External trigger	Input via I/O connector (Line0)
Input level	Low: 0 to 0.5V, High: 3.3 to 24.0V
Input Current	5 to 15mA
Polarity	High active / Low active (factory setting: Low active)
Pulse width	200μs (minimum)
Input circuit	<p>Photo coupler input</p>  <p>* Depending on cable length, cable kinds and input current of trigger input line, Random Trigger Shutter operation may not satisfy timing specification or camera may not receive EXT_TRIG signal.</p>
Software trigger	GigE Vision Command (GVCP) control
Exposure time	Timed mode, TriggerWidth mode (factory setting: Timed)
Timed mode	The exposure time depends on the MANUAL Exposure time setting
TriggerWidth mode	The exposure time depends on External trigger width
Trigger Delay	0 to 4095μs (factory setting: 0μs)
Anti-Chattering sampling period	2 to 1,000μs (factory setting: 2μs)

6.5 GPIO Output signal specification

Output channel	2 channels	
Output line name	Line1	Line2
Output signal	VD, TIMER0 ACTIVE, EXPOSURE ACTIVE, FRAME ACTIVE, FRAME TRANSFER, FRAME TRIGGER WAIT	
Output level	LVTTL	Open Collector
Maximum Current	+/-24mA (drive current)	50mA (input current)
Output circuit	<p>The diagram illustrates the GPIO Signal Output Circuit. It is divided into two sections by a dashed line. The top section shows Line1 (3pin) connected to GPIO0. The bottom section shows Line2 (4pin) connected to GPIO1 through a TLPS291 optocoupler. The circuit includes a Vcc supply, a pull-up resistor, and an I/O_GND (5pin) connection.</p>	
Polarity	High active / Low active (factory setting: Low active)	
TIMER0 ACTIVE		
Delay	0 to 2000000μs (factory setting: 0s)	
Duration	0 to 2000000μs (factory setting: 0s)	

6.6 Interface specification

Interface	Gigabit Ethernet IEEE802.3ab (1000BASE-T) conformity
Transmission speed	1Gbps (Maximum)
Protocol	GigEVision Camera Interface Standard for Machine Vision Ver 1.2
Conformity cable	Twist pair (Category 5e or over)
Cable length	Up to 100m (at the Unshielded Twist Pair (UTP) cable)

6.7 Image output format

Model	BG030	BG031	BG080	BG130	BG202
Image output format	GVSP_PIX_MONO8 : Mono 8 bit				
	GVSP_PIX_MONO10 : Mono 10 bit				
Maximum Frame rate (at the all pixel readout)	125 fps	125 fps	40 fps	30 fps	20 fps

Notes on Dropping Frames:

Depends on your PC or Gigabit Ethernet interface board configurations, images may not be captured properly (e.g. dropping frames). In this case, change to frame rate setting lower.

6.8 Event notification

Event name	FrameTrigger, FrameTriggerError, FrameTriggerWait ALCLatestInformation, ALCConverged
Event notification delay	approx. 4ms later from the event occurs
Time stamp unit	16ns (62.5MHz)

6.9 Machine external specification

Dimensions	29 mm(W) x 29 mm (H) x 40 mm (D) (Not including protrusion)
Mass	Approximately 53g
Lens mount	C-mount
Flange back	17.526 mm
Camera body grounding insulation status	Non-conductive between circuit GND and camera body

6.10 Operation Ambient conditions

Operation assurance	Temperature: 0°C to +40 °C, Camera housing temperature: less than 50 °C Humidity: 10% to 90% (no condensation)
Storage assurance	Temperature: -20°C to +60 °C Humidity: 90% or less (no condensation)
EMC condition	EMI (Electro-Magnetic interference) : EN61000-6-4 FCC Part 15 Subpart B Class A EMS (Electro-Magnetic susceptibility) : EN61000-6-2

Notes on Heat Radiation:

The temperature of camera housing must be kept less than 50 °C.
Please provide sufficient heat radiation depending on your installation.

Notes on Conformity of the EMC:

The adaptability of the safety standard of this camera is assured in the condition of combination with the following parts:

<<PoE operation>>

- PoE Switch GS108P-100AJS (NETGEAR Inc.)
- LAN Cable C5e(S-HFR)(K)-* (Oki Electric Cable Co., Ltd.)

<<DC operation>>

- DC Cable CPCBG-03
- LAN Cable C5e(S-HFR)(K)-* (Oki Electric Cable Co., Ltd.)

Please confirm the EMC adaptability when it combines with parts other than them.

6.11 Connector pin assignment

Gigabit Ethernet interface connector

RJ-45 Jack

Pin No.	I/O	Signal Name	Function
1	I/O	BI_DA+ / VDC+	Bidirectional Data A (+) / Power (+)
2	I/O	BI_DA- / VDC+	Bidirectional Data A (-) / Power (+)
3	I/O	BI_DB+ / VDC-	Bidirectional Data B (+) / Power (-)
4	I/O	BI_DC+ / VDC+	Bidirectional Data C (+) / Power (+)
5	I/O	BI_DC- / VDC+	Bidirectional Data C (-) / Power (+)
6	I/O	BI_DB- / VDC-	Bidirectional Data B (-) / Power (-)
7	I/O	BI_DD+ / VDC-	Bidirectional Data D (+) / Power (-)
8	I/O	BI_DD- / VDC-	Bidirectional Data D (-) / Power (-)

I/O Connector

Connector (Camera side)

HR10A-7R-6PB(73) (Hirose) or equivalent

Plug (Cable side)

HR10A-7P-6S(73) (Hirose) or equivalent

Camera cable is not an accessory of this product.

Pin assignment

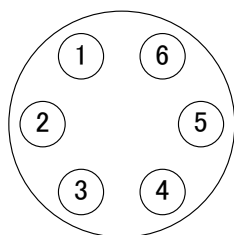

* Above figure is connector view from insert side.

Pin No.	I/O	Signal Name	Function
1	I	+12V	Power
2	I	Line 0	External Trigger Input
3	O	Line 1	GPIO_0 Output
4	O	Line 2	GPIO_1 Output
5	-	I/O GND	GPIO_Ground
6	-	GND	Ground

Notes on Power Supply:

This camera has two ways of power supply,

- Supply from LAN cable (PoE)
- Supply from camera cable (DC+12V \pm 10%)

If both PoE and DC+12V are connected, power is supplied from PoE.

6.12 Typical spectral response

The lens characteristics and light source characteristics is not reflected in table.

< BG030 >

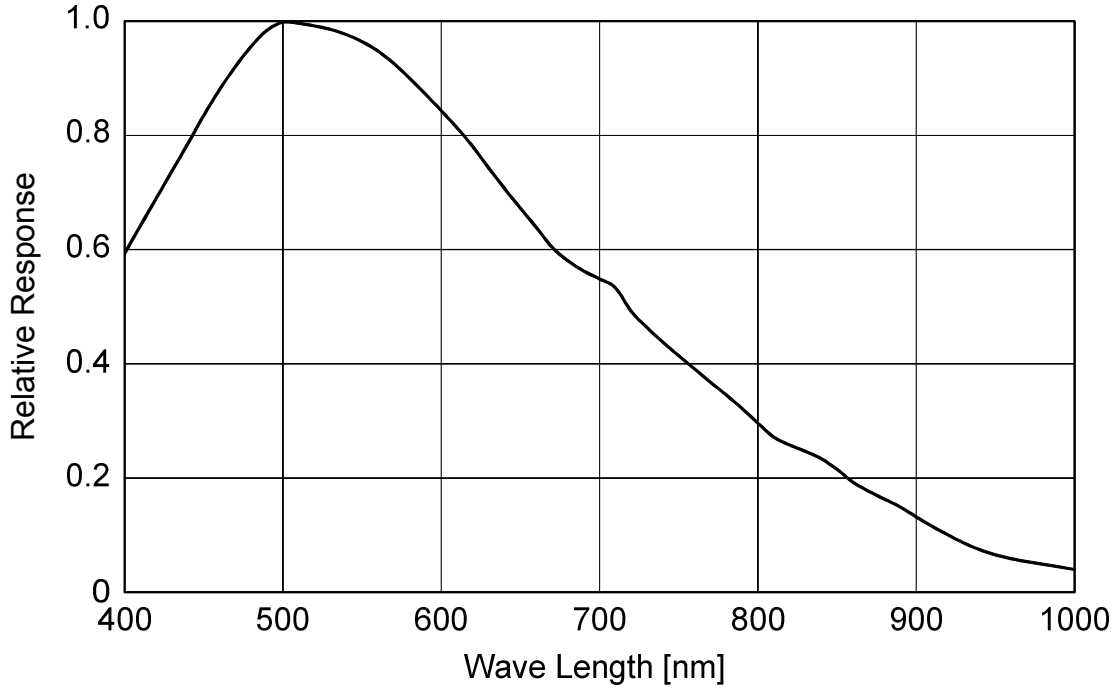

< BG031 >

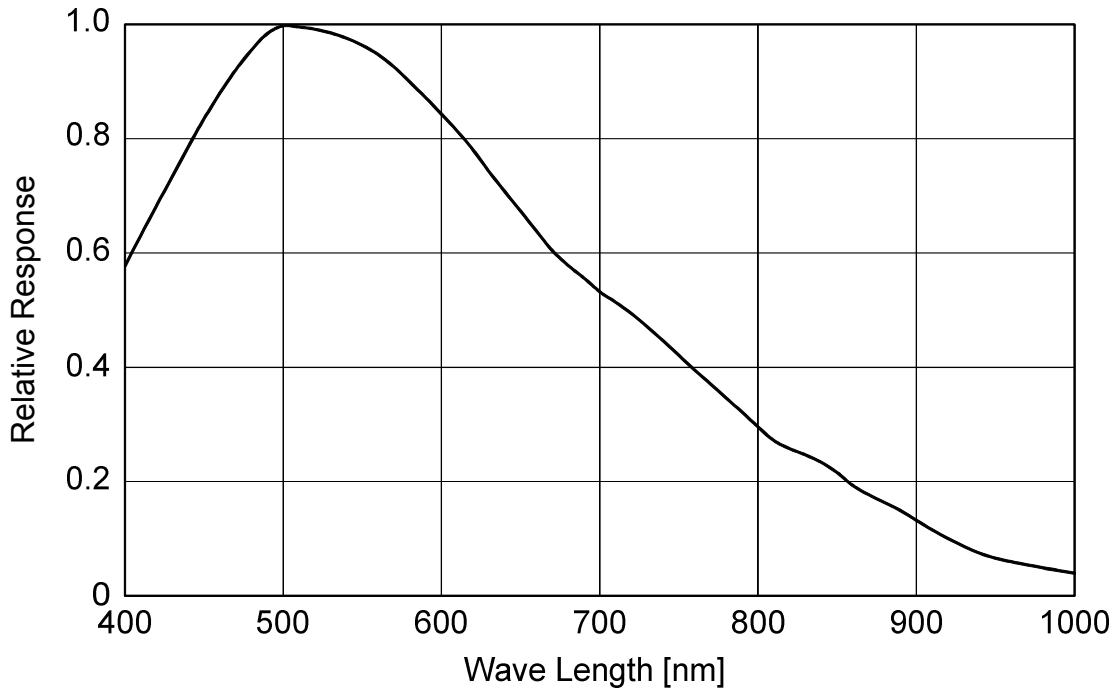

< BG080 >

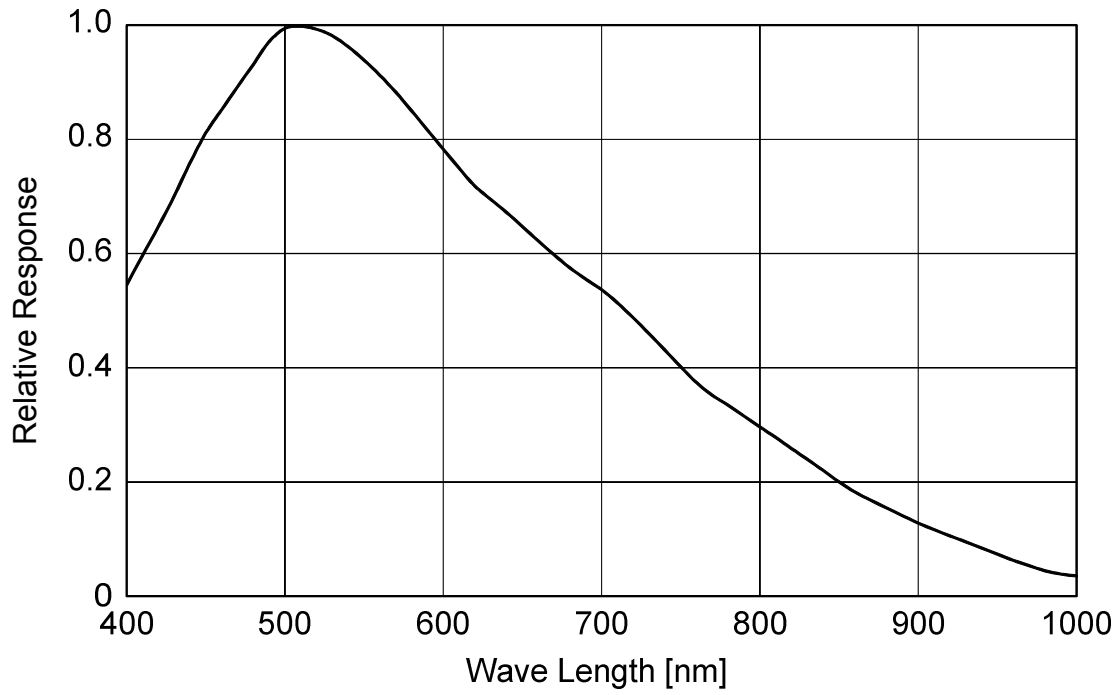

< BG130 >

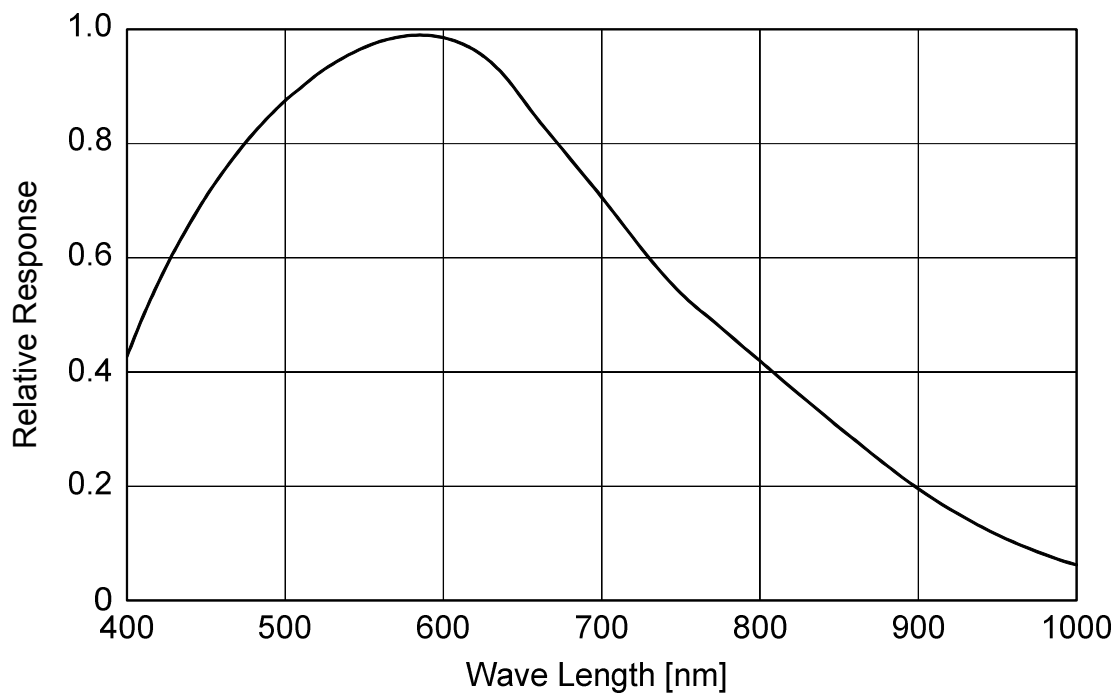

< BG202 >

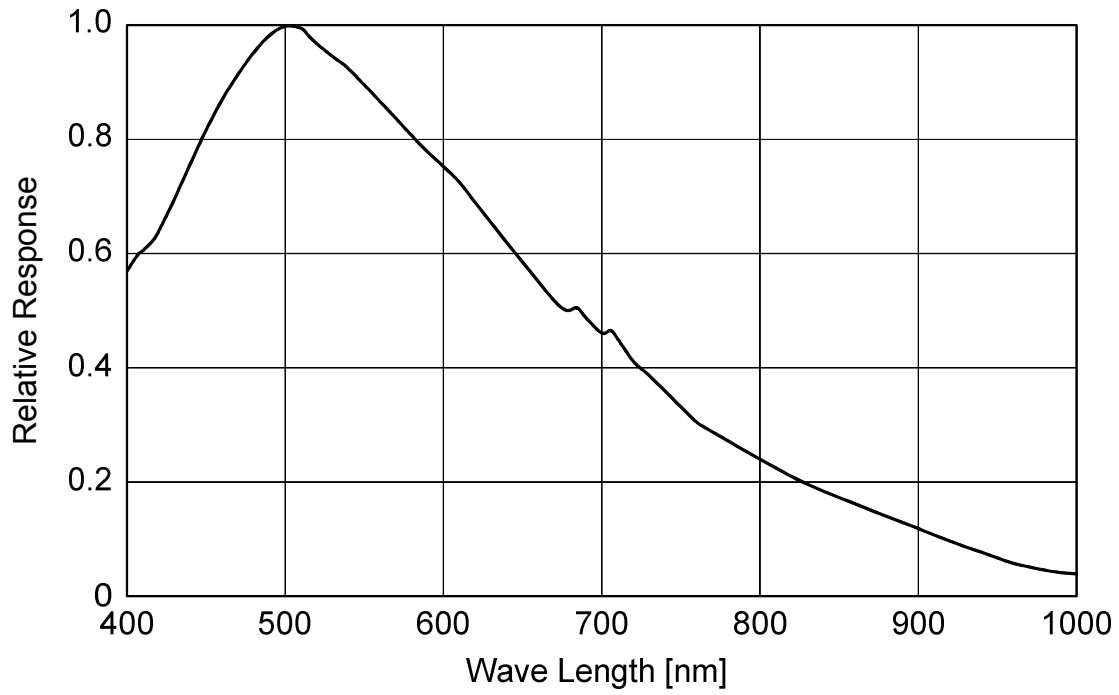

7 Timing chart

Image data outputs are transferred with the UDP protocol of Gigabit Ethernet. Timing numerical value below is described by absolute prerequisite that camera can use transmission band without restriction of other node. When there is other node using the same network, the value described below is not guaranteed.

7.1 GbE bus transfer timing

Video format: MONO 8bit, all pixel readout

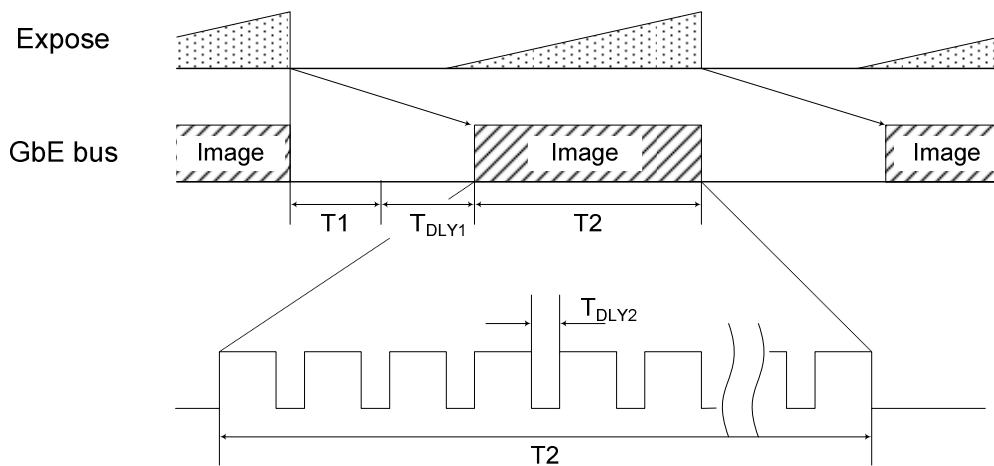

Model Name	T1 [ms]	T2 [ms]	Default Frame Rate [ms]
BG030	see following formula.	same as Frame Rate.	8.0
BG031			8.0
BG080			25.0
BG130			33.3
BG202			50.0

* TDLY1 : GVSP_BLOCK_START_DELAY

* TDLY2 : SCPD (Stream Channel Packet Delay)

* $T1 = (T2 / (\frac{\text{PayloadSize}}{\text{SCPS} - 36})) \times 3$, $T1 = 100\mu\text{s}$ or longer.

PayloadSize is total bytes of single frame.

The formula applies when SCPS (Stream Channel Packet Size) is 1500 byte / packet.

(T1 varies depending on the value of SCPS)

7.2 Random Trigger Shutter timing

7.2.1 External trigger signal input

The specifications of external trigger input signal are as follows;

- Trigger amplitude : +3.3 to +24V
- Pulse width : Minimum 200μs

The received external trigger signal delays as follows.

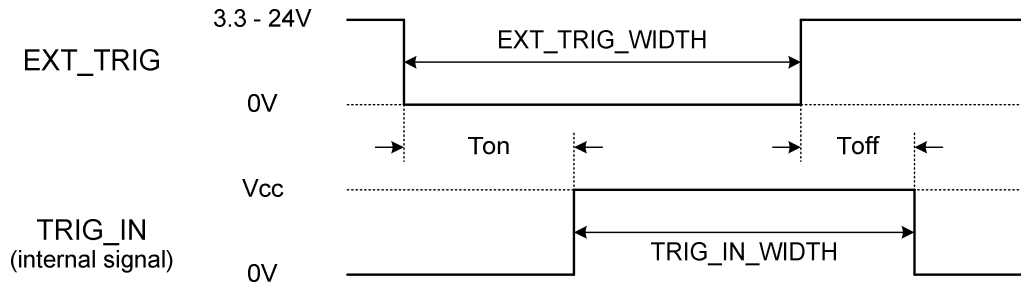

(a) Negative trigger

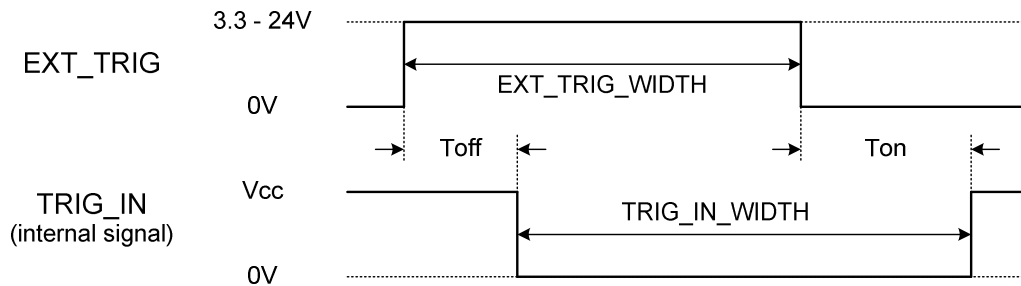

(b) Positive trigger

EXT_TRIG_WIDTH: The pulse width of the external trigger input (more than 200μs).

Toff: The delay time of falling edge.

Ton: The delay time of rising edge.

TRIG_IN_WIDTH: The pulse width of the trigger signal which is received inside of the camera.

- Negative trigger: $TRIG_IN_WIDTH = EXT_TRIG_WIDTH - (T_{on} - T_{off})$
- Positive trigger: $TRIG_IN_WIDTH = EXT_TRIG_WIDTH + (T_{on} - T_{off})$

Trigger amplitude	Toff [μs]	Ton [μs]
+3.3V	2.92	26.2
+12V	2.12	31.2
+24V	2.12	31.2

* Toff and Ton are typical value.

* These values vary depending on operating environment.

7.2.2 Timed mode (Video format: MONO 8bit, all pixel readout)

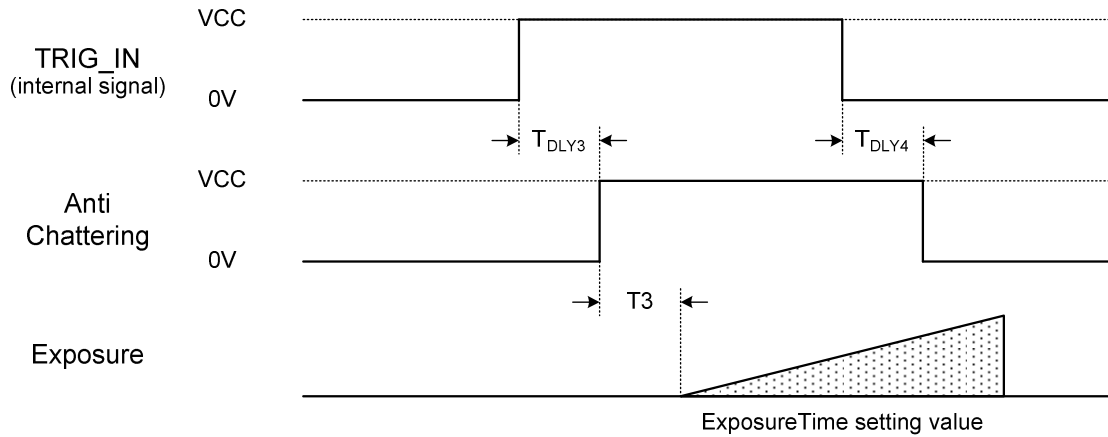

7.2.3 TriggerWidth mode (Video format: MONO 8bit, all pixel readout)

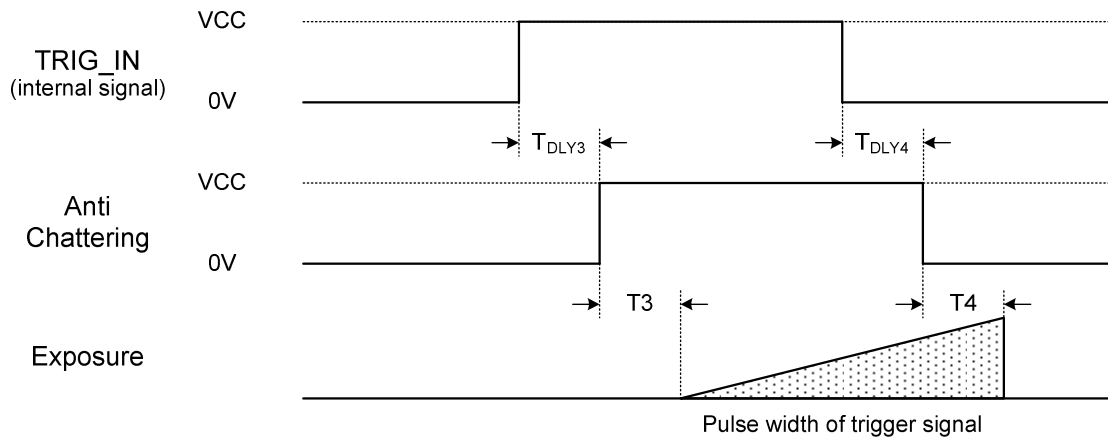

Model Name	T3 [μ s]	T4 [μ s]
BG030	1.0	2.5
BG031	1.0	2.5
BG080	2.2	34.0
BG130	1.2	7.1
BG202	1.5	5.9

* TDLY3, TDLY4: TriggerSamplingPeriod (typical value)

Max TriggerSamplingPeriod x 1.625[μ s], Min TriggerSamplingPeriod x 0.625[μ s]

* T3 and T4 are typical value.

Notes on Random Trigger Shutter mode:

- In the period when FRAME_TRIGGER_WAIT signal is inactive, user must not input external trigger signal to this camera.
- When the interval of the input trigger signal is extremely short, or when the trigger signal is noisy, there is a possibility of causing the malfunction. In this case, please input a proper trigger signal.

7.2.4 GPIO signal output

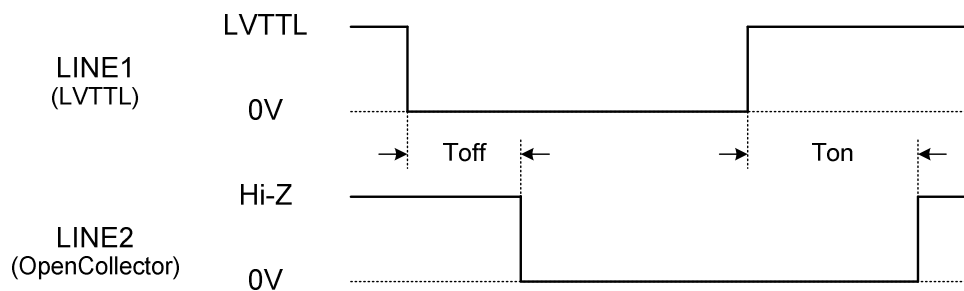

(a) ActiveLow

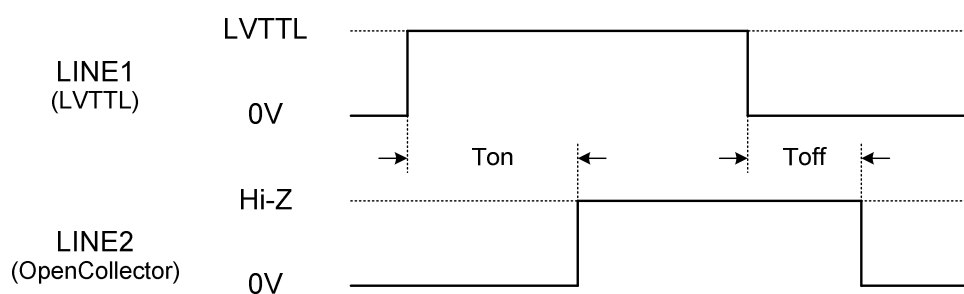

(b) ActiveHigh

T_{off} : LINE1~LINE2 falling delay time

T_{on} : LINE1~LINE2 rising delay time

LINE2 amplitude	T_{off} [μ s]	T_{on} [μ s]
+3.3V	3	53.2
+12V	4	78.4
+24V	5	94.4

* T_{off} and T_{on} are typical value.

* These values vary depending on operating environment.

8 Warranty rules

8.1 Warranty term

Warranty term is 36 months after your purchase. We may assume the date of the purchase from our shipping date when the date is unidentified.

8.2 Limited Warranty

Free warranty is not applicable for the troubles, damages or losses caused by the cases of the followings, even if it is during the warranty term.

1. Natural exhaust, wear or degradation of a component parts
2. Handling against the instructions and conditions described in the instruction manual
3. Remodeling, adjustment and the part exchange. (including the opening of the enclosure box and the alteration)
4. Using the accessories not included with the product or our non-designated optional articles
5. Damages caused during the transportation or deficiency of the handling such as drop or fall of the products after the products having been transferred to customers, leaving the products to corrosive environment such as sunlight, fire, sand, soil, heat, moisture, or an inappropriate storing method
6. A fire, an earthquake, a flood, a lightning, or other natural disasters, pollution and a short circuit, abnormal voltage, excessive physical pressure, theft, other accident
7. When connected to a product which is not recommended
8. When connected to the power supply which is not suitable
9. Forgery product, products which does not have proper serial number, products of which serial number is forged, damaged or deleted
10. All defects that happened after the expiration for a warranty term

9 Repair

9.1 Repair Methods

Exchange to a replacement or an equal function product.

9.2 Repair request methods

On the occasion of a repair request, please return the defective product with the failure situation report sheet to be filled out.

Please read the following instructions carefully.

1. Please return our product alone, taking out of your equipment in case that our product is installed to an equipment
2. We are unable to return the information such as your own serial numbers, control number, the identification seal, if it is attached to the returned products. Please keep record before you return the product.
3. As the data saved in the camera will not be kept after the repair, please take out data before return.
4. We are unable to accept the cancellation after the repair request by the customer's reason.
5. About the repair product shipping expenses, please bear the charges when you return the product to us. We bear the charges to you from us only for a warranty period.
6. We are unable to accept your request of a delivery date and time of the product return, or the delivery method.
7. We are unable to accept a trouble factor investigation, the request of the repair report.
8. We accept a repair of out of warranty product, if it is reparable.
9. The proprietary rights of the repair request products after the exchange repair belong to us.
10. The immunity from responsibility of the product is applied in the repair completion products.

* Please refer for the inquiry about the software to our homepage or sales personnel.

10 Outline Drawing

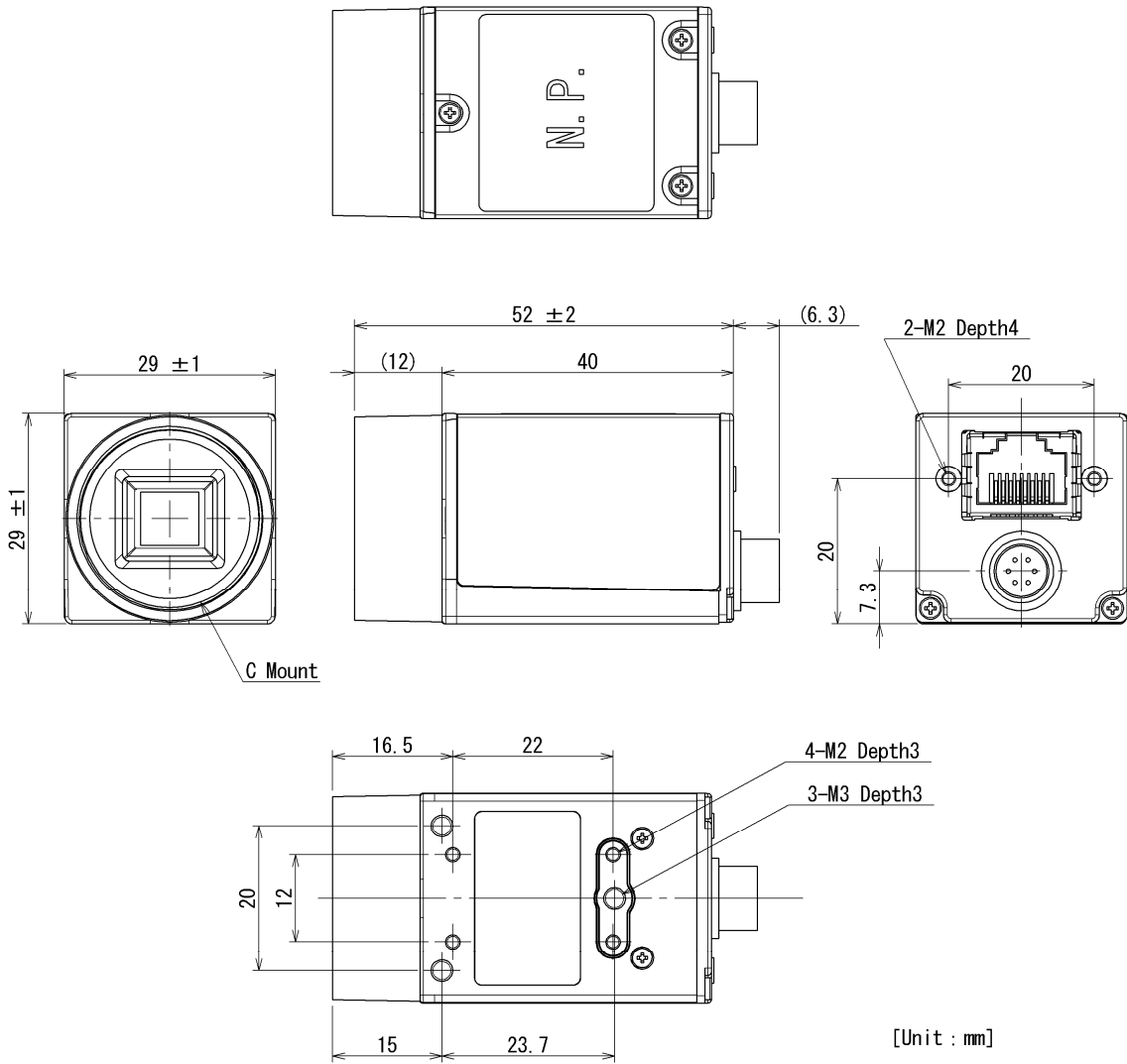

In order to grasp the details of failure,
please fill out the following information, and send us the defective product with this report sheet enclosed.

(1) Customer information

Company Name		Department	Your Name
Telephone number	E-Mail address		FAX number
Postal code number	Address		

(2) Return address Please fill out this information, if the return address is different from above address (1).

The offered personal information is not used for any purposes other than after-sale service, such as repair of a product and an inquiry, and the questionnaire of the improvement in customer satisfaction.
Moreover, except for the case where it commissions within limits required for the above-mentioned purpose achievement, it does not indicate to a third party without a visitor's consent.
We pay careful attention and manage a visitor's information.

(3) We suggest a possible solution before your repair request.

Please ensure your safety when you check following items.

Please handle power supply with proper procedure, and make sure it does not impede any operation.

a) Restart the power supply of this product.	Check → <input type="checkbox"/> Tried <input type="checkbox"/> Not Tried
Please turn off this product once, switch on a power supply again after passing for a while, and confirm operation.	
b) Exchange for other products.	Check → <input type="checkbox"/> Tried <input type="checkbox"/> Not Tried
Please exchange for other same products, and confirm operation.	
c) Connect to other PC systems.	Check → <input type="checkbox"/> Tried <input type="checkbox"/> Not Tried
Please connect this product to other PCs, and confirm operation.	
d) Check Specifications of this product.	Check → <input type="checkbox"/> Tried <input type="checkbox"/> Not Tried
Please confirm that specifications of this product conform to usage environment referring to following URL. URL:http://www.toshiba-teli.co.jp/index.htm Please check our website for the latest information.	

(4) Failure situation

■ Accrual date

Model name	Serial No.	Your dealer
		Purchase date
Failure condition: (Please fill out the phenomenon in detail.)		

(5) From when

- Unknown From the beginning After a while
 After environment was changed.

(Others _____)

(6) Occurrence frequency

- Unknown It certainly occurs. It sometimes occurs.
 It occurs, after time passes.

(Others _____)

<For dealer use>

Reception date :

Receipt No. :

JOB No. :

Check :