

Matrox Supersight e2 >>>

High-performance computing (HPC) platform for computationally-demanding industrial imaging.

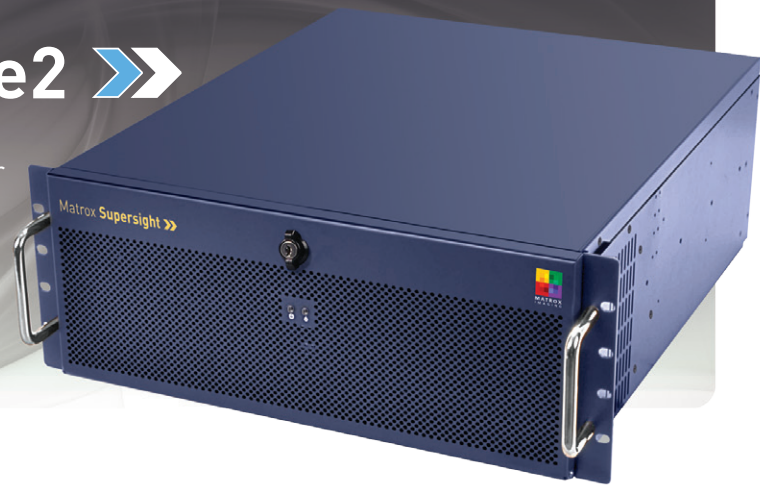

Benefits

Tackle extreme applications with certainty using a high-performance compute cluster platform

Harness the full power of today's multi-core CPU, GPU, and FPGA technology to provide image processing offload and acceleration

Eliminate I/O bottlenecks with a unique PCIe® 2.0 switched fabric backplane architecture

Directly interface to external process equipment through the integrated Gigabit Ethernet, RS-232/485 and USB 2.0 connectivity

Minimize the need for revalidation by utilizing a lifecycle managed platform with consistent long term availability

Simplify system integration by using an integrated platform from a single vendor and pre-qualified third-party components

Solve applications rather than develop underlying tools by leveraging standard Microsoft® development tools, Matrox Imaging Library (MIL)

HPC for imaging

Matrox Supersight brings together the latest technologies from multi-core CPUs to GPUs to FPGAs in a single pre-validated high-performance computing (HPC) platform, allowing OEMs to focus on developing applications with cutting-edge performance instead of integrating components. Matrox Supersight is fully supported by Matrox Imaging Library (MIL), an established collection of software tools for developing industrial imaging applications, in order to extract the maximum performance from the platform and deliver a complete solution in a timely manner. Backed by a carefully managed lifecycle and long term availability, the Matrox Supersight is a solid foundation for your next computationally-demanding application.

Processing trinity

Achieving maximum performance requires using the right technology in the right place within the application. FPGAs show great strength with image pre-processing tasks, general purpose CPUs are ideal for image processing and analysis, and GPUs provide substantial acceleration for image processing primitives. Matrox Supersight enables developers to put together all of these technologies into a complete HPC platform with enough compute density to surpass blade server offerings.

Consistent long-term availability

Carefully selected components are coupled with strict change control to ensure consistent long-term supply. Longevity of a stable supply lets OEMs maximize return on the original investment without incurring the additional costs associated with repeated validation of constantly-changing mainstream commercial platforms.

Distinctive switched fabric

A unique PCIe® 2.0 backplane provides the switched fabric to group processing elements (CPUs, GPUs and FPGAs) into compute clusters. Utilizing the point-to-point full-duplex nature of PCIe®, bus traffic from compute clusters is isolated ensuring optimal performance with increasing accelerator count. Unlike classical segmented backplanes, the Matrox Supersight backplane, through the Distributed MIL (DMIL) communication API, enables segments/clusters to look like a unified system.



Matrox Supersight SHB-5220

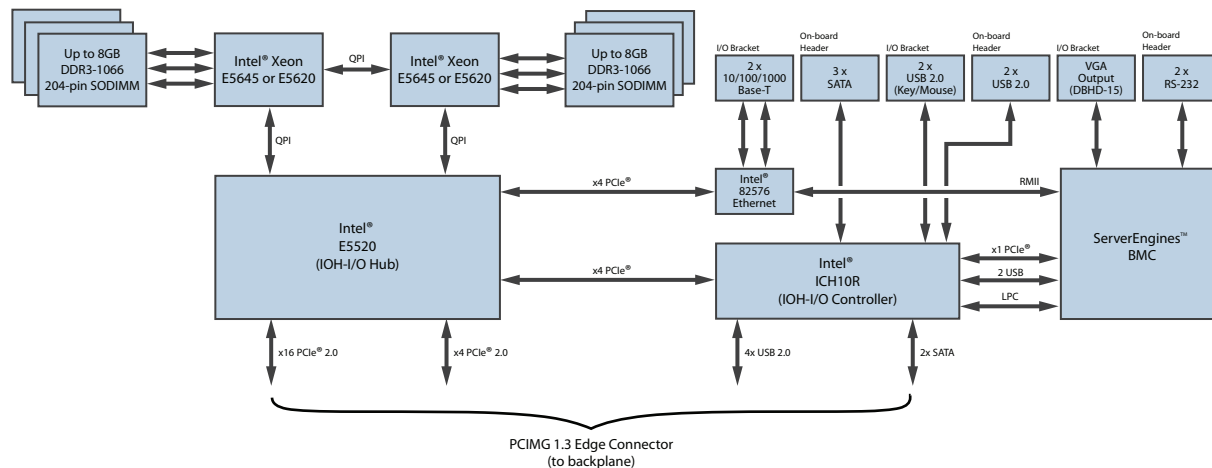

Easy integration and management

Matrox Supersight's high density makes it easy for OEMs to incorporate it into their systems. System health monitors including temperature, voltage and fan speed, in combination with a watchdog timer, allow the Matrox Supersight to detect, report and recover from errors and failures, quickly returning the system to operational status.

System Host Board (SHB)

With up to twelve 64-bit Intel® cores split between two processors, each directly attached to memory and two Quick Path Interconnects (QPI), the Matrox SHB-5520 is ideally suited for the most demanding processing tasks. Advanced interrupt handling and hardware acceleration in the Intel® 82576 Gigabit Ethernet controller balance the Ethernet load between the CPUs freeing valuable resources for image processing.

Code Portability

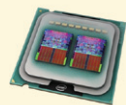

Multi-core CPU

```
MsysAlloc(M_SYSTEM_HOST, ..., &MilSystem);
...
MbufAlloc2d(MilSystem, ..., &SrcImage);
...
MimConvolve(SrcImage, DestImage, Kernel);
```



GPU

```
MsysAlloc(M_SYSTEM_GPU, ..., &MilSystem);
...
MbufAlloc2d(MilSystem, ..., &SrcImage);
...
MimConvolve(SrcImage, DestImage, Kernel);
```

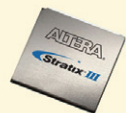

FPGA

```
MsysAlloc(M_SYSTEM_RADIENT, ..., &MilSystem);
...
MbufAlloc2d(MilSystem, ..., M_ON_BOARD, &SrcImage);
...
MimConvolve(SrcImage, DestImage, Kernel);
```

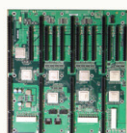

DMIL

```
MsysAlloc("DMILPCIE:\\computer\M_SYSTEM_HOST, ..., &MilSystem);
...
MbufAlloc2d(MilSystem, ..., &SrcImage);
...
MimConvolve(SrcImage, DestImage, Kernel);
```

Matrox Supersight SHB-5520 (cont.)

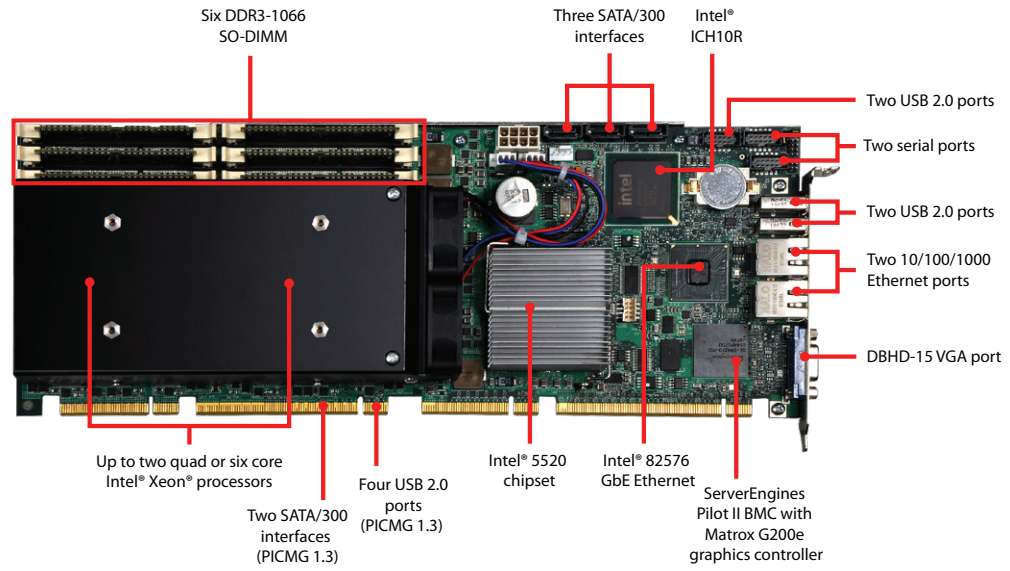

Matrox SuperSight chassis



Front view



Rear view

Backplane

A 14-slot PCIe® 2.0 backplane provides substantial expansion opportunities for Matrox and third-party acquisition, I/O, display and offload accelerators.

Power and storage

A massive 2040W power supply enables the system to accommodate multiple accelerators, frame grabbers, GPUs and CPU boards. Integrated 2.5" hard drives provide a greater level of shock and vibration resistance over standard desktop models. Quick release, hot swappable drive bays with RAID support increase system reliability and ease system maintenance.

Expansion options

Matrox Imaging provides the components necessarily to create a scalable computing platform. Through the high-bandwidth PCIe® 2.0 switched fabric backplane, data can be moved seamlessly between acquisition and processing devices with negligible transfer times.

PCIe® 2.0 Backplane

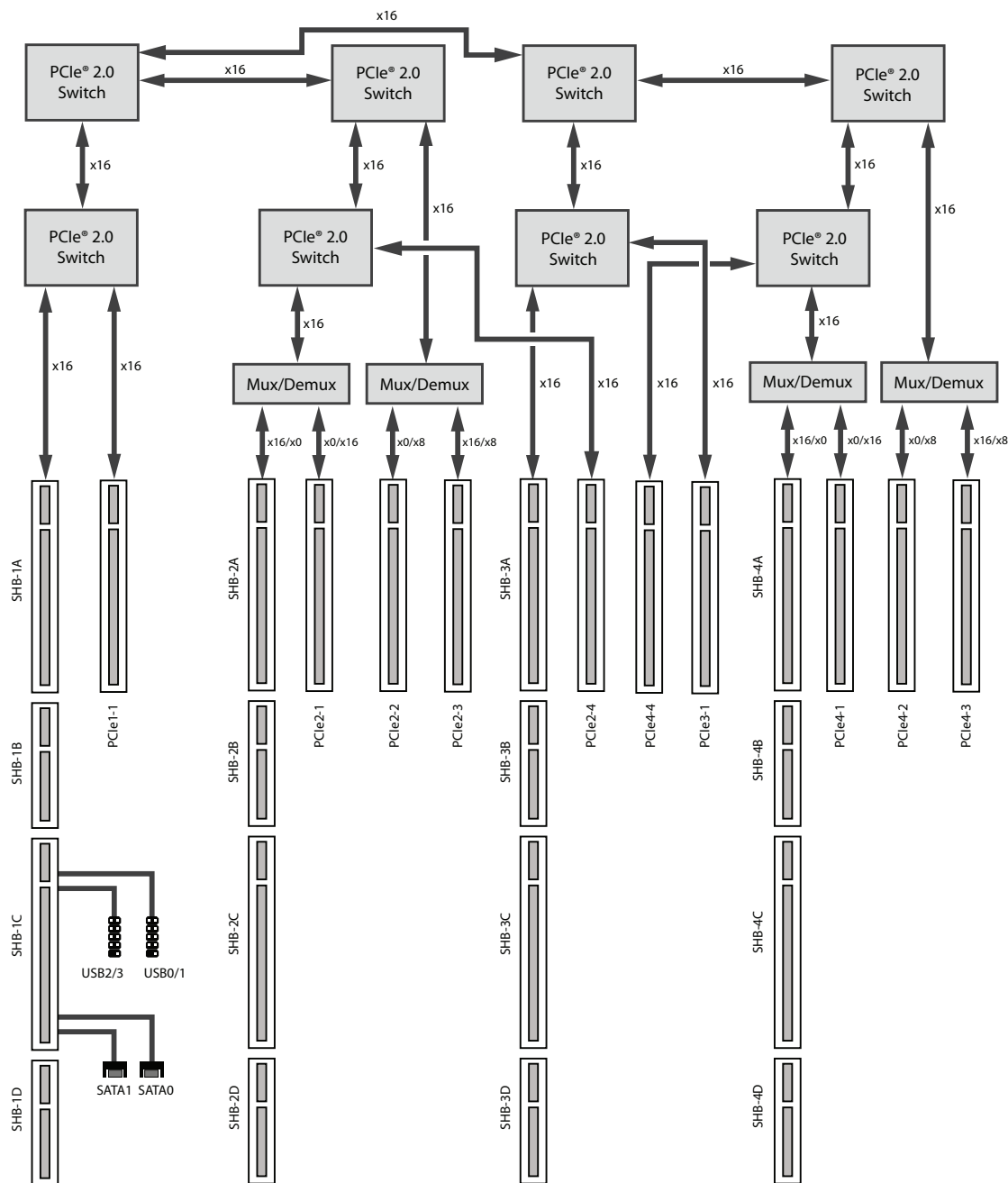

Acquisition

Matrox Imaging provides the industry's most comprehensive line of image acquisition boards covering all major interfaces including Camera Link®, DVI-D, GigE Vision™, IEEE 1394 IIDC, SDI, Digital (RS-422/LVDS) as well as standard and non-standard analog. Refer to the individual Matrox interface boards brochures for more information.

Processing acceleration

FPGA-based image processing is a powerful addition to an image acquisition board providing substantial offload of the host processors for image processing primitives without consuming additional slots. Refer to the Matrox Radient eCL brochure for further details.

GPU-based image processing, through the use of pre-installed AMD professional graphics adapters, provides substantial acceleration for sequences of image processing primitives. Refer to the "Ordering Information" section for available options.

CPU-based image processing provides the ultimate flexibility providing optimal performance for high-level image processing routines.

Software Environment

Operating System

Matrox Supersight comes pre-loaded with Microsoft® Windows® 7 Professional for Embedded Systems, which provides all the features of the standard operating system with an extended life cycle needed to ensure longevity of supply. Native 64-bit support enables the handling of large amounts of system memory.

Matrox Imaging Library (MIL)

A complete imaging platform needs to include not only hardware but a robust development environment. The Matrox Imaging Library (MIL) is a high-level programming library with an extensive set of optimized functions for capture, processing, analysis, display, I/O and archiving. Refer to the MIL brochure for additional information.

As new processing and acceleration hardware becomes available, MIL with its common high-level API, enables developers to quickly and easily adapt the application to take full advantage of the performance provided by these with minimal recoding; effectively protecting the original development investments.

MIL is licensed for the Matrox Supersight on a per chassis basis. A Matrox Supersight automatically has access to MIL-Lite and Distributed MIL (DMIL) functionality. Additional privileges licensed on the master Matrox SHB-5520 are automatically propagated to slave Matrox SHB-5520s³.

Scalable computing example configurations

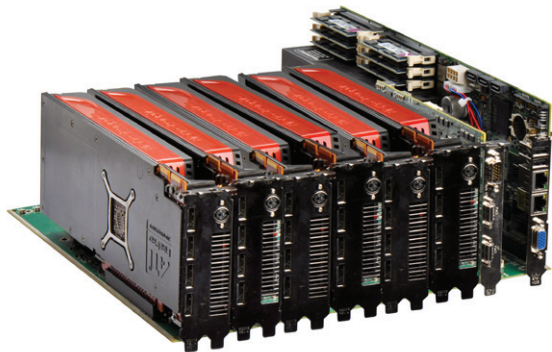

- One cluster with:
- One FPGA (Matrox Radient eCL)
 - Two CPUs (Matrox SHB-5520)
 - Six GPUs (double-wide)



- Four Clusters with:
- One FPGA (Matrox Radient eCL)
 - Two CPUs (Matrox SHB-5520)

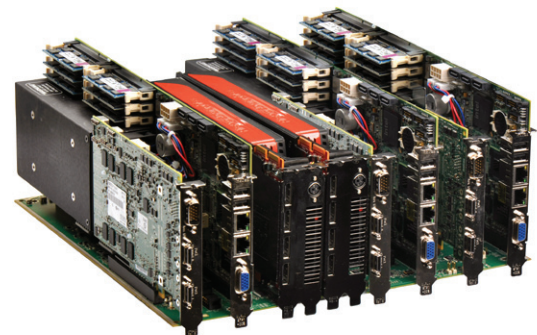

- One Cluster with:
- One FPGA (Matrox Radient eCL)
 - Two CPUs (Matrox SHB-5520)
- And Two clusters with:
- One FPGA (Matrox Radient eCL)
 - Two CPUs (Matrox SHB-5520)
 - One GPU

Specifications

System Host Board (SHB)

- PICMG 1.3 SHB
 - one (1) PCIe® x16 2.0
 - one (1) PCIe® x4 2.0 (Gen 2)
- Intel® 5520 (Tylersburg 36D) + ICH10R chipset
- two(2) 1336-pin LGA Sockets
- up to two (2) Intel® Xeon® processor 5600 series
 - 80W maximum
- 5.86 GT/s QPI Interface
- Matrox G200e graphics controller
 - one (1) RGB (VGA) display output
 - up to 1600 x 1200 @ 60 Hz
- six (6) 204-pin SODIMM Sockets
- up to 48GB DDR3 - 1066 non-ECC unbuffered SDRAM
- five (5) SATA/300 3.0 Gbps ports with raid 0,1, and 10 support
 - three (3) on-board
 - four (4) through PICMG 1.3 edge connector (backplane)
- two (2) Gigabit Ethernet ports (10/100/1000)
- eight (8) USB 2.0 ports
 - two (2) on the PCI bracket
 - two (2) through pin headers
 - four (4) through PICMG 1.3 edge connector (backplane)
- two (2) RS-232/RS-485 serial ports
- hardware health monitoring
 - fan
 - temperature
 - voltage

14-Slot PCIe® 2.0 Backplane

- four (4) PICMG 1.3 host slots
- ten (10) PCIe® 2.0 x16 75W slots¹
- two (2) SATA/300 connectors
- three (3) USB 2.0 connectors
 - two (2) ports per connector

CPU options

- two (2) Intel® Xeon® processors E5645
 - six-core
 - 2.4 GHz
 - 5.86 GT/s QPI
 - 12 MB Last Level cache
 - 64-bit architecture
- two (2) Intel® Xeon® processors E5620
 - quad-core
 - 2.4 GHz
 - 5.86 GT/s QPI
 - 12 MB Last Level cache
 - 64-bit architecture

Memory options

- 6 GB DDR3-1066
- 12 GB DDR3-1066
- 24 GB DDR3-1066
- 48 GB DDR3-1066

Hard disk options

- up to four (4) hard disks
 - up to 250 GB
 - SATA/300
 - 7200 RPM
 - 16 MB cache
 - hot swappable

Optical drive options

- one (1) slim optical disk drive
 - 24x CD R/W
 - 8x DVD-ROM
 - SATA/300
 - 2 MB cache

Chassis

- Dimensions
 - length: 48.0 cm (19.5")
 - width: 48.2 cm (19.0")
 - height: 4U, 17.8 cm (7.0")
- Mounting
 - 19" rackmount
 - Removable rack ears
 - Removable rack handles
- Drive bays
 - front-accessible
 - four (4) 2.5", hot-swappable hard disk bays
 - one (1) slim CD/DVD bay
- I/O Interfaces
 - six (6) USB 2.0 ports
 - four (4) front accessible
 - two (2) internal with license dongle retention
- Additional features
 - hinged front panel with lock
 - ATX rocker power switch
 - recessed reset button
 - power and HDD notification LEDs
 - fifteen (15) slots

Specifications (cont.)

Power supply

- 2040 W power supply
- AC input
 - 100-240VAC
 - 47-63 Hz
 - 40 A
 - Power factor corrected
- DC output
 - +3.3VDC @ 80A²
 - +5 VDC @ 110A²
 - +12VDC @ 150A
 - -12VDC @ 2.5A
 - +5VSB @ 4A
- supplemental power connectors
 - seven (7) 4-pin peripheral (12V DC & 5V DC)
 - one (1) 4-pin SP4 peripheral (12V DC & 5V DC)
 - four (4) 8-pin EPS CPU
 - six (6) 6-pin PCIe® Power 75W (12V DC)
 - or 8-pin PCIe® Power 225W

Certifications

- FCC class A
- CE class A
- RoHS-compliant

Operating system

- pre-loaded with Microsoft® Windows® 7 Professional 64-bit for Embedded Systems

Environmental

- 10°C (50°F) to 35°C (95°F) operating temperature
- -40°C (-40°F) to 85°C (185°F) storage temperature
- up to 90% (non-condensing) relative humidity

Dimensions



Ordering Information

Hardware

| Part number | Description |
|-----------------------|--|
| SS4E1-MTRX-04* | Matrox Supersight e2 with single SHB-5520 featuring two (2) Xeon® E5620 CPUs, 12 GB DDR3 SDRAM, 250 GB HDD and Microsoft® Windows® 7 Professional 64-bit for Embedded Systems. Includes 14-slot PCIe® 2.0 backplane and 2040w power supply. |
| SS4E2-MTRX-04* | Matrox Supersight e2 with two (2) SHB-5520s each featuring two (2) Xeon® E5620 CPUs, 12 GB DDR3 SDRAM, 250 GB HDD and Microsoft® Windows® 7 Professional 64-bit for Embedded Systems. Includes 14-slot PCIe® 2.0 backplane and 2040w power supply. |
| SS4E3-MTRX-04* | Matrox Supersight e2 with three (3) SHB-5520s each featuring two (2) Xeon® E5620 CPUs, 12 GB DDR3 SDRAM, 250 GB HDD and Microsoft® Windows® 7 Professional 64-bit for Embedded Systems. Includes 14-slot PCIe® 2.0 backplane and 2040w power supply. |
| SS4E4-MTRX-04* | Matrox Supersight e2 with four (4) SHB-5520s each featuring two (2) Xeon® E5620 CPUs, 12 GB DDR3 SDRAM, 250 GB HDD and Microsoft® Windows® 7 Professional 64-bit for Embedded Systems. Includes 14-slot PCIe® 2.0 backplane and 2040w power supply. |

Software

Refer to Matrox Imaging Library (MIL) brochure.

GPU option (add the following to the above configurations)

| Part number | Description |
|-----------------------------|--|
| Call for part number | ATI Fire Pro V7800 single-width GPU card with 2GB GDDR5 memory and 1440 stream processors. |
| Call for part number | ATI Fire Pro V8800 double-width GPU card with 2GB GDDR5 memory and 1660 stream processors. |

Note:

1. Maximum of 144 active lanes, see block diagram for valid configurations.
2. Maximum power of 710W for combined 3.3V and 5V.
3. Does not apply to independent clusters.

Corporate headquarters:

Matrox Electronic Systems Ltd.
1055 St. Regis Blvd.
Dorval, Quebec H9P 2T4
Canada
Tel: +1 (514) 685-2630
Fax: +1 (514) 822-6273

For more information, please call: 1-800-804-6243 (toll free in North America) or (514) 822-6020
or e-mail: imaging.info@matrox.com or <http://www.matrox.com/imaging>

All trademarks by their respective owners are hereby acknowledged. Matrox Electronic Systems, Ltd. reserves the right to make changes in specifications at any time and without notice. The information furnished by Matrox Electronic Systems, Ltd. is believed to be accurate and reliable. However, no responsibility license is granted under any patents or patent rights of Matrox Electronic Systems, Ltd. Windows and Microsoft are trademarks of Microsoft Corporation. © Matrox Electronic Systems, 2009-2011. 2011-05-25. **\$IE-5470-B**

